

100 min

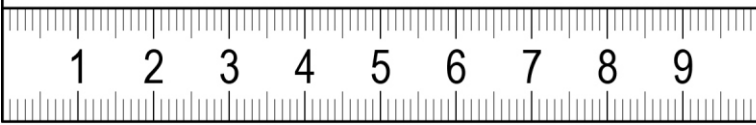

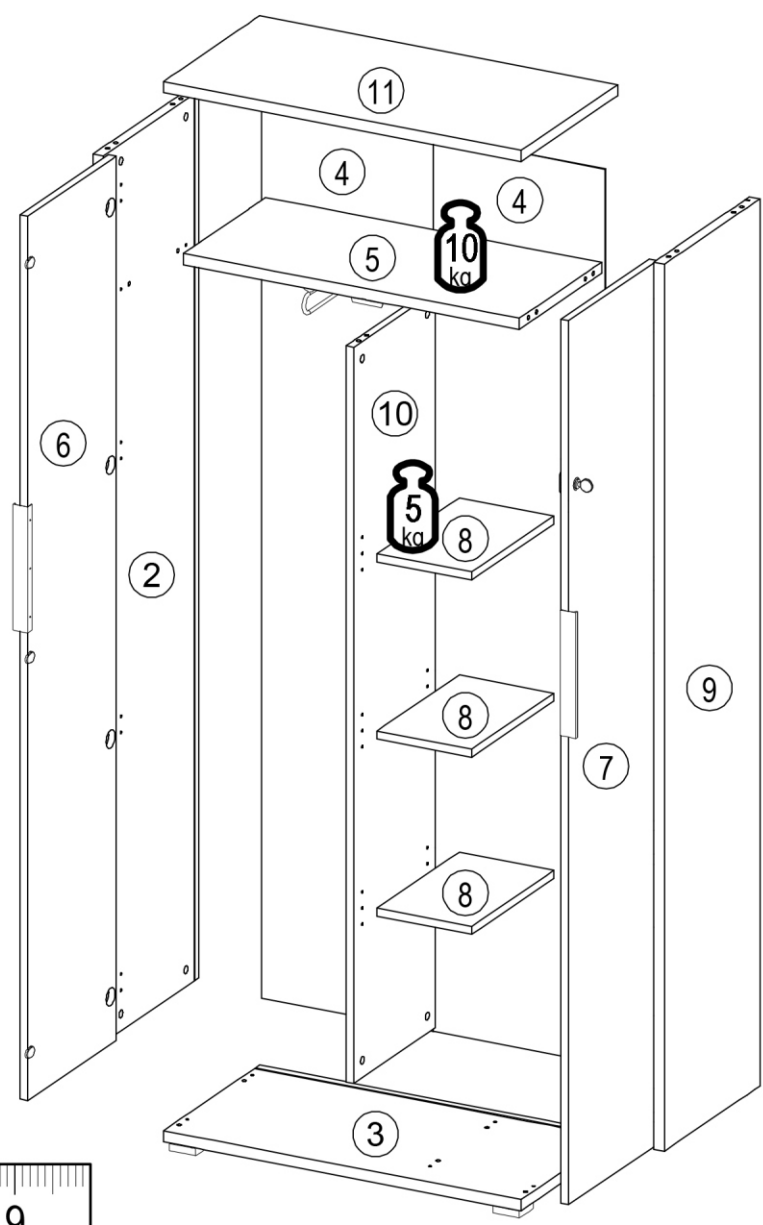

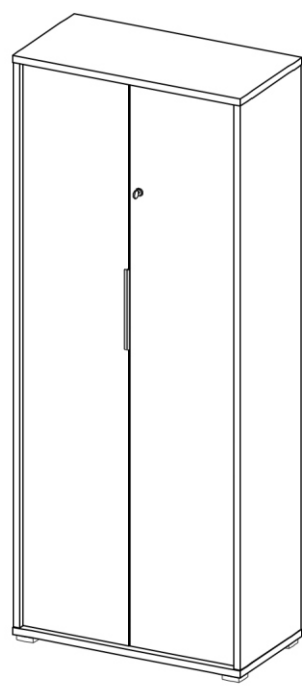



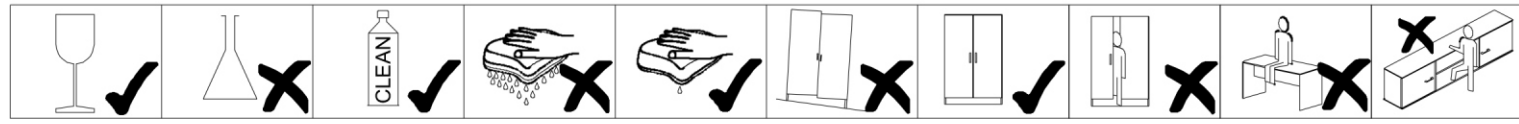

 PZ 1, PZ 2
 ≤ 0,5 kg
 3m

| ID | ID | Image | Quantity | Assembly Order |
|-------|----|--------------|----------|----------------|
| 13928 | 2 | 1762*376*22 | 1x | 1/3 |
| 13929 | 3 | 750*380*22 | 1x | 2/3 |
| 12815 | 4 | 1778*360*2,5 | 2x | 1/3 |
| 13930 | 5 | 704*324*22 | 1x | 2/3 |
| 13931 | 6 | 1756*348*16 | 1x | 3/3 |
| 13932 | 7 | 1756*348*16 | 1x | 3/3 |
| 13933 | 8 | 198*324*16 | 3x | 2/3 |
| 13934 | 9 | 1762*376*22 | 1x | 1/3 |
| 13935 | 10 | 1462*322*16 | 1x | 1/3 |
| 13936 | 11 | 750*380*22 | 1x | 2/3 |







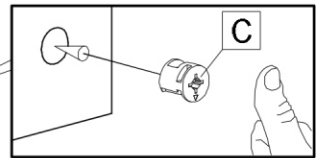
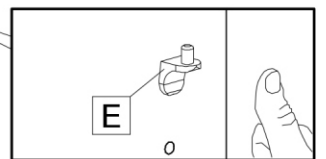
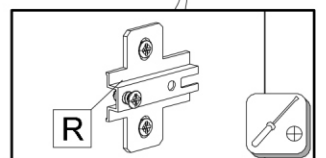
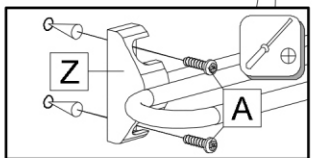
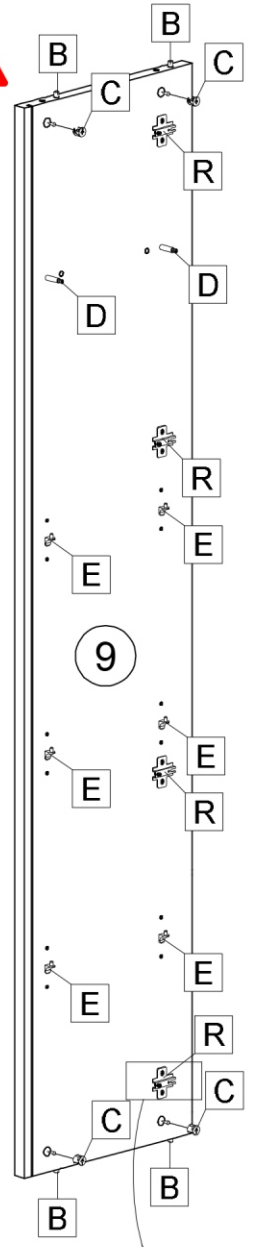
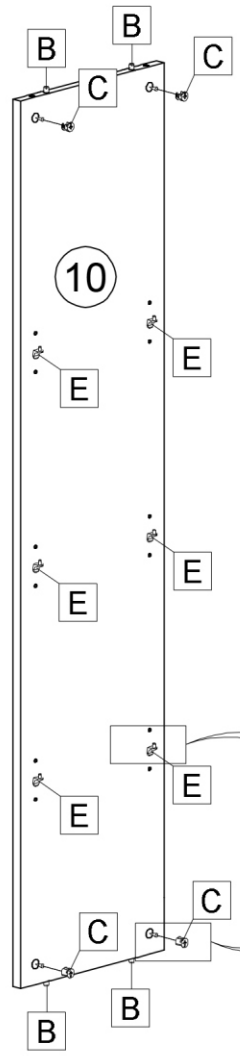
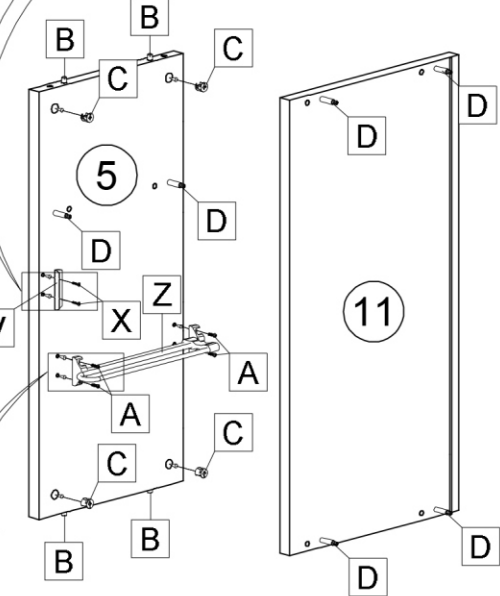
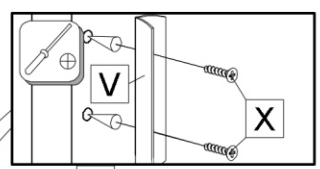
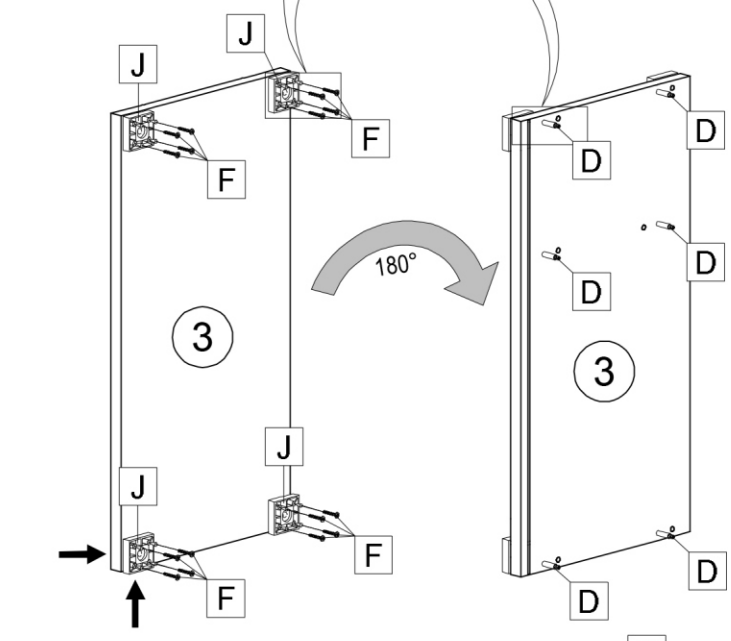
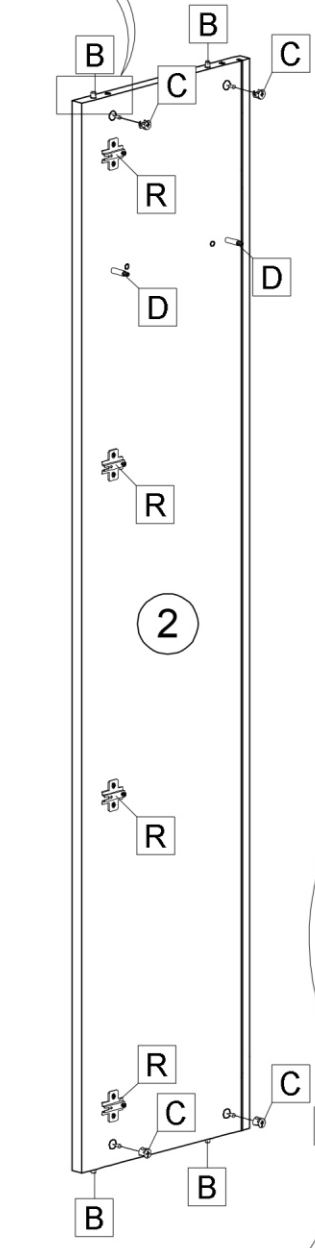
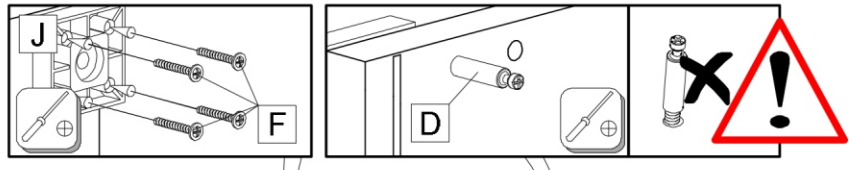
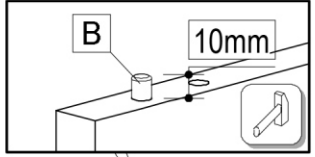

| | | | | | | | | | |
|------------------------------|---------------------------|----------------------------|-------------------------------|------------------------------|---------------------------|---------------------------|----------------------------|-------------------|------------------|
| 22244,01 Ø3,5*16 A 6x | 24008,00 3,0 A1 13x | 27000,00 Ø8*30 B 16x | 30200,01 B1 3x | 70013,01 C 16x | 70021,01 D 16x | 8501,00 E 12x | 22060,00 Ø4x30 F 16x | 50553,00 G 16x | H 12x |
| 30083,00 55x55x20 J 4x | 31103,00 K 1x | 22213,00 Ø4x70 L 1x | 24103,00 Ø8 M 1x | 22243,00 Ø3,5x15 N 16x | 34197,00 O 1x | 22234,00 Ø3x12 P 6x | 36001,01 Q 8x | 36001,01 R 8x | 32242,00 S 2x |
| 8402,03 T 2x | U 4x | 34002,03 V 1x | 22236,00 Ø2,5x16 V1 20x | 22246,00 Ø3,5x12 X 2x | 22223,02 Ø4x20 Y 4x | 31001,01 Z 1x | | | |

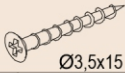

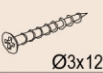
| | | | | | | | | | |
|--|---|---|---|---|---|--|---|---|---|
|  |  |  |  |  |  |  |  |  |  |
| A 4x | B 16x | C 16x | D 16x | E 12x | F 16x | J 4x | R 8x | V 1x | X 2x |
|  | | | | | | | | | |
| Z 1x | | | | | | | | | |



| | | | | | | |
|---|---|---|---|---|---|--|
|  |  |  |  |  |  |  |
| B1 3x | N 16x Ø3,5x15 | O 1x | P 6x Ø3x12 | Q 8x | S 2x | Y 4x Ø4x20 |

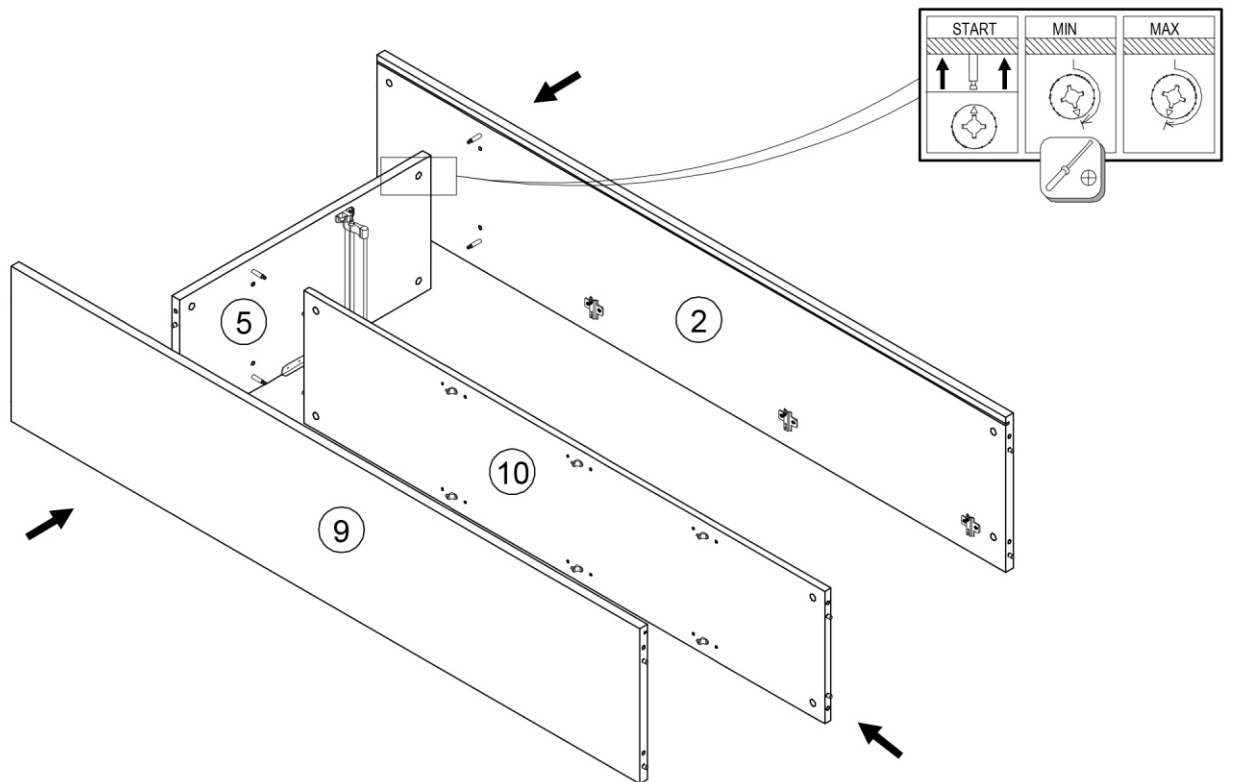
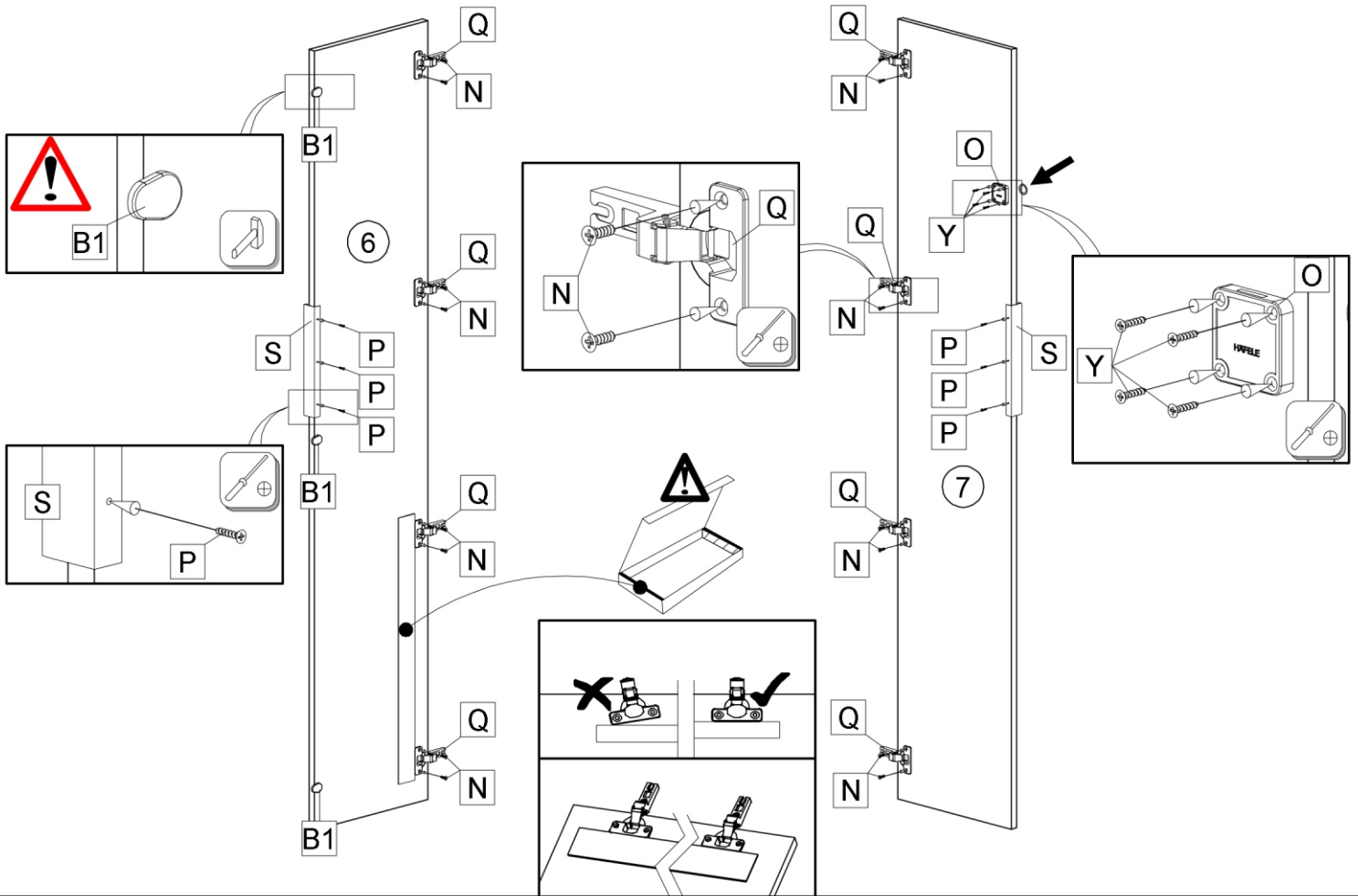

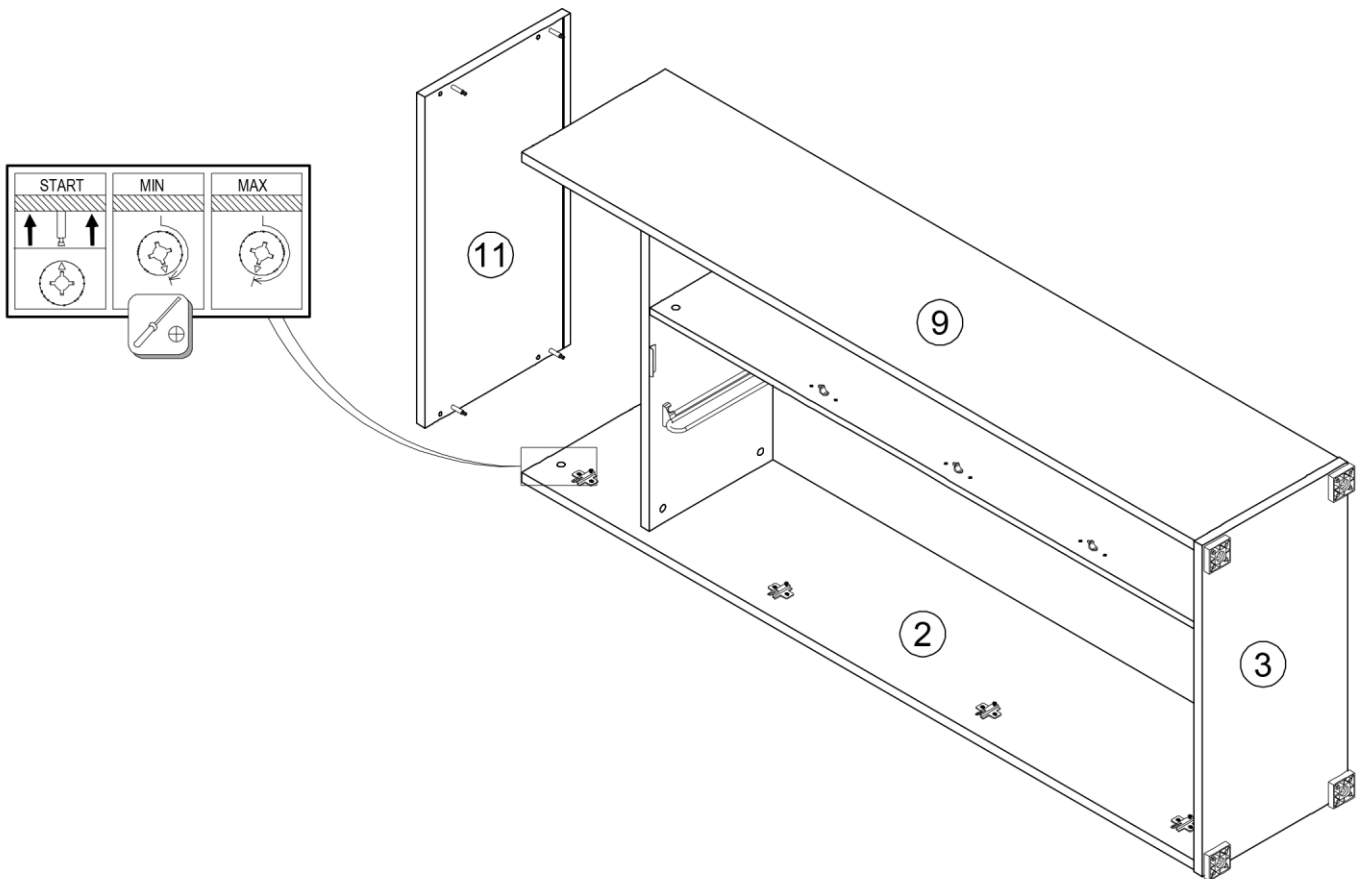
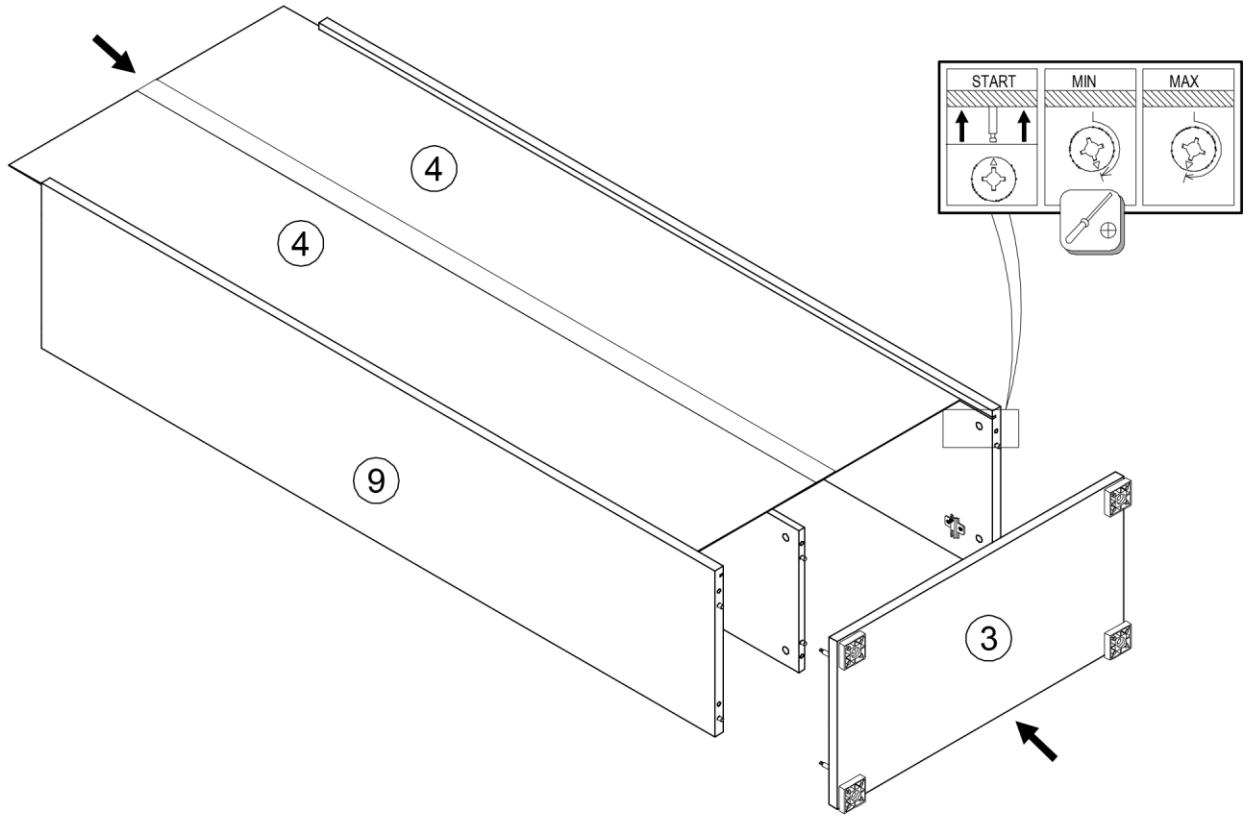

| | | |
|--------|-------|---------|
| | | |
| Ø3,0 | | Ø2,5x16 |
| A1 13x | G 16x | V1 20x |

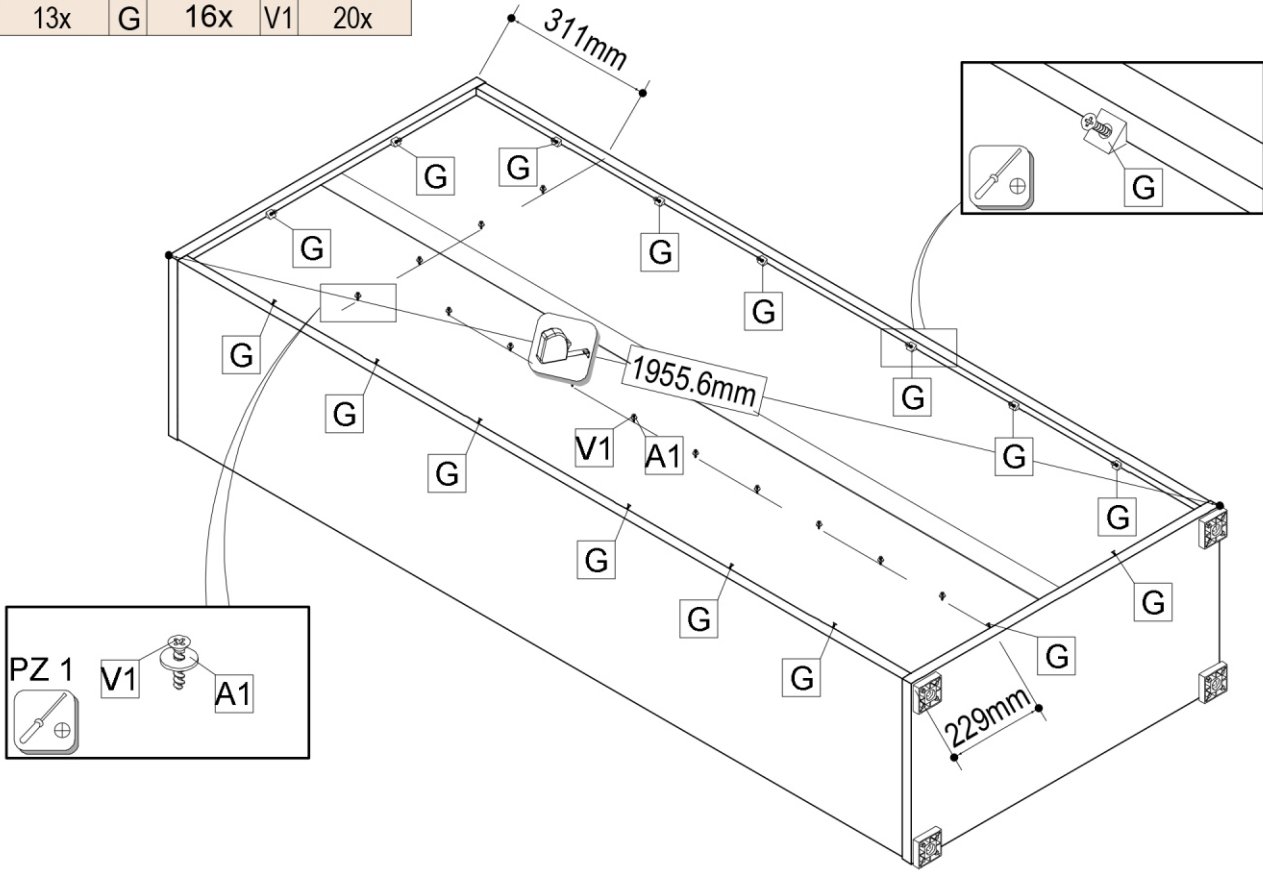

| | | | |
|---------|------|-------|------|
| | | | |
| Ø3,5*16 | | Ø4x70 | Ø8 |
| A 2x | K 1x | L 1x | M 1x |

- v = 1785
- Ø8
- M
- K, A
- K, L

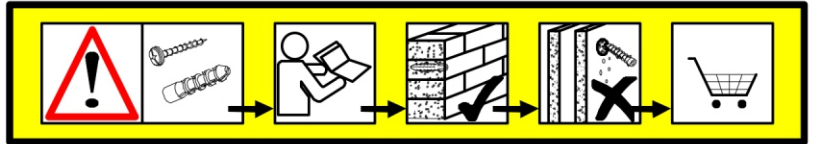
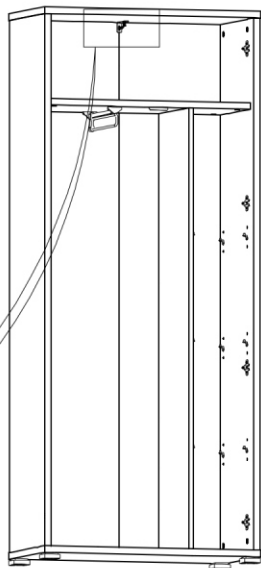

| | | | |
|------------|--|-----------|---|
| DE | Achtung! Die Wandbeschaffenheit ist vor der Montage unbedingt zu prüfen. Die beigelegten Universaldübel sind ausschließlich nur zur Verwendung für festes Mauerwerk wie Beton/Ziegel. Die Mauerdübel dürfen nicht bei Mauerwerk wie Hohlraumziegel, Leichtbausteinen, Gipskartonplatte oder anderer Rahmenbauweise verwendet werden. Bei diesen Mauerwerken sind gegebenenfalls Spezialdübel zu verwenden! Diese sind in einem Fachgeschäft (Baumarkt) erhältlich. Bei Nichterhaltung wird seitens Produzenten/Händler und Importeur keine Haftung übernommen. | EN | Caution! The wall must be examined before assembly. The included universal wall plugs are only suitable for using in firm masonry such as concrete block or brick. Do not using the wall plugs masonry such as hollow brick, lightweight block, surfaces such as gypsum plasterboard or other framing systems. If applicable, particular wall plugs must be used! These are available at a specialised store (hardware store). In case of non-compliance, the manufacturer/retailer or importer do not assume liability. |
| SLO | Pozor! Pred montažo preverite stanje stene. Priloženi univerzalni mozniki so združeno samo za uporabo na čvrstem zidu, kot sta beton in opeka. Slabši mozniki se ne smejo uporabljati pri zidu, kot so votlina opeka, zidaki za lahko gradnjo, mavčne plošče ali druge okvirne gradnje. Pri teh zidovih morate v danih primerih uporabljati posebne moznike. Ti so na voljo v specializiranih trgovinah (trgovinah z gradbenim materialom). Pri upoštevanju se s strani proizvajalca/trgovca in uvoznika ne prevzame jamstvo. | HR | Pažnja! Prije montaže obavezno provjerite svojstvo zida. Priložene univerzalne tipke namijenjene su isključivo za masivne zidove od betona/opeke. Tipke za masivne zidove ne smiju se koristiti za zidove kao npr. šupljina opeka laki sastavni element, gips kartonske ploče ili drugi modularni načini gradnje. Za te zidove potrebne su eventualno specijalne tipke! Iste su dostupne u specijaliziranim trgovinama građevinskog materijala. U slučaju nepodržavanja prethodno navedenih napomena, proizvođač/trgovac i uvoznik ne preuzimaju odgovornost! |
| SK | Upozornenie! Pevnosť steny sa musí pred montážou bezpodmienečne skontrolovať. Univerzálne hmoždenky, ktoré sú obsahnuté v balení, používajte jedine pre pevné murivo ako je betón/tehla. Hmoždenky sa nesmú používať v prípade ľahkého stavebného muriva, dutá tehla, u sádkartónových desiek alebo iných konštrukcií rámu. U týchto murív je nutné použiť špeciálne hmoždenky! Tieto je možné dostať v špeciálnych predajniach so stavebným materiálom (stavebniny). Pri nedodržaní pokynov nepreberajú výrobcovia/predajci a dodávateľa zodpovednosť za vzniknuté škody. | CZ | Upozornění! Před montáží je nutné zkontrolovat stav stěny. Priložené univerzální hmoždinky jsou určeny pouze k použití pro pevné zdivo jako beton/cihla. Hmoždinky do zdi se nesmí používat u dutové cihly, zdiva jako pórovitý stavební kámen, sádkartónová deska nebo jiný měkký materiál. U těchto zdív jsou nutné použít speciální hmoždinky! Jsou k dostání v speciálních prodejnách se stavebním materiálem. Při nedodržení těchto pokynů výrobce/prodejce a dopravce neručí za způsobené škody. |
| HU | Vigyázat! Szerelés előtt a faljelétet feltétlenül vizsgálja meg. A mellékelt univerzális tipk kizárólag stabil falazathoz használható mint például beton/cégla. A fal tipk nem használható könnyű építkezésekhez, üreg téglák, gipszkarton lapokhoz vagy más lágyabb építkezésekhez. Ezekhez a faljelétekhez csak speciális tipk használhatóak, melyek szaküzletekben (barkácsárúházaokban) beszerezhetőek. Fentiek figyelmen kívül hagyása esetén a gyártó/kereskedő vagy forgalmazó nem vállal felelősséget. | S | OBS! Väggens sammanställning ska absolut kontrolleras innan monteringen. De bifogade pluggarna får endast användas för stabila och fasta väggar, som t.ex. betong/tegel. De får absolut inte användas för kavlett tegel, väggar ur tonit, gipskivor eller dylikt. För dessa väggar måste det användas speciella pluggar, som finns att köpa i specialiserad handel (byggmarknad). Varken tillverkare, handlare eller importör övertar ansvar, om dessa anvisningar inte följs. |

| | | |
|--|---|---|
|  |  |  |
| H 12x | T 2x | U 4x |

